



CONSTRUCTION SEATING



OFF ROAD SEATING MANUFACTURER



UnitedSeats for construction vehicles

“We unite your seat”



UnitedSeats is a worldwide manufacturer of off road seating solutions for the industrial, agricultural, construction and marine sectors. All seats are produced under contract for us in a state of the art modern 75,000 m² facility using the latest manufacturing techniques.

We are based in Zwijndrecht, the Netherlands, from where we supply a portfolio of OEMS and a dealer network around the world. UnitedSeats remains committed to innovation, providing seating products and supported by excellent sales and service support.

Our in-house design capability allows us to tailor products for OEM and dealer specification. Our range comprises a selection of air and mechanical suspensions which are both high profile and low profile, importantly for small & compact construction machines low profile.

These suspensions can be combined with a wide selection of seat uppers and seat pans. Our skill is 'Uniting your seat'.







Our construction seats are heavy duty and our latest models like the LGV120/C8 Pro can accommodate driver weights up to 150 kgs. Our MG35 and MG55 seats meet EM1 to EM3 & EM5 to EM9 for construction vehicle categories. All our suspension seats meet ISO 6683, seat belt strength approval, ISO 7096, construction vibration approval, and all SIP dimensions are according to ISO 5353.

UnitedSeats has a wide range of accessories, such as safety critical items, like seat belts and seat switches. Special armrests and pods are available to carry joystick controls for various machines. A wide variety of spare parts such as dampers and cushions can be supplied.

Above all, our priority is to supply seating solutions to maintain the health and safety of the operator. We also emphasize the need to maintain and repair damaged seats to prevent injury.

At UnitedSeats we've got your back!

We have seats for the following machinery:

-  Excavator
-  Large wheeled loaders
-  Medium wheeled loaders
-  Small wheeled loaders
-  Road rollers & compactor machinery
-  Backhoe loaders
-  Skid steer & compact track loaders
-  Site dumper
-  Telescopic handler
-  Bulldozer

Focus product range

LGV120/C8 PRO 3P

Our latest range of seats is heavy duty and ideal for large construction equipment such as wheeled loaders, excavators, large telescopic, bulldozers and compactors. The LGV120 suspension has a simple updown lever to adjust the air ride. It can accommodate drivers up to 150 kgs. It is available with 12v or 24v integral compressor and a mechanical MG120 is also available.

With the strong C8 Pro upper it can also be fitted with 3-point or 4-point seat belts. It can also be delivered with pods for joystick controls.





LGV120/C8 PRO





STANDARD FEATURES

-  **Air suspension**
100 mm suspension travel

-  **Weight adjustment**
50 - 150 kg

-  **Slide rail travel**
200 mm

-  **Backrest adjustment**

-  **Seat cushion depth & tilt adjustment**

-  **Lumbar support**

-  **Headrest**

SEAT MEASUREMENTS

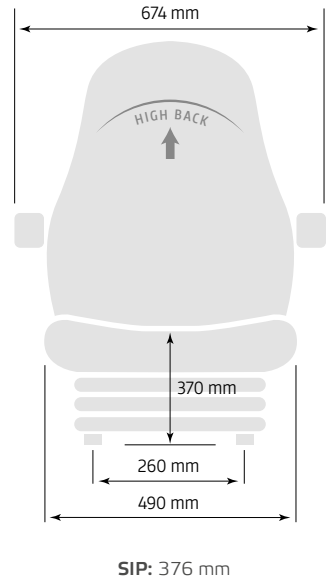

OPTIONAL FEATURES

On photo

-  **Armrests**





Seat is also available in PVC trim

MGV120/C8 PRO 3P





STANDARD FEATURES

-  **Mechanical suspension**
100 mm suspension travel

-  **Weight adjustment**
50 - 150 kg

-  **Slide rail travel**
150 mm

-  **Backrest adjustment**

-  **Seat cushion depth & tilt adjustment**

-  **Lumbar support**

-  **Headrest**

SEAT MEASUREMENTS

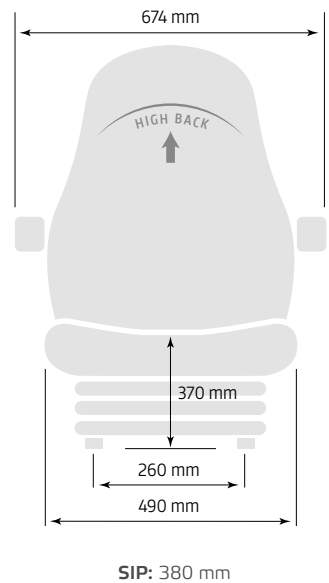

OPTIONAL FEATURES

On photo

-  **Armrests**
-  **Seat belt**





Seat is also available in PVC trim

MGV120/C8 PRO





STANDARD FEATURES

-  **Mechanical suspension**
100 mm suspension travel

-  **Weight adjustment**
50 - 150 kg

-  **Slide rail travel**
200 mm

-  **Backrest adjustment**

-  **Seat cushion depth & tilt adjustment**

-  **Lumbar support**

-  **Headrest**

SEAT MEASUREMENTS

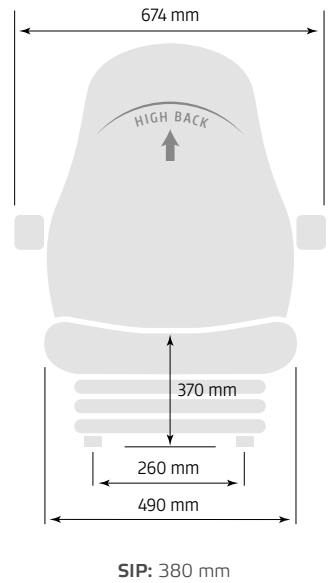

OPTIONAL FEATURES

On photo

-  **Armrests**





Seat is also available in PVC trim

LGV120/C7 PRO





STANDARD FEATURES

-  **Air suspension**
100 mm suspension travel

-  **Weight adjustment**
50 - 150 kg

-  **Slide rail travel**
200 mm

-  **Backrest adjustment**

-  **Seat cushion depth & tilt adjustment**

SEAT MEASUREMENTS

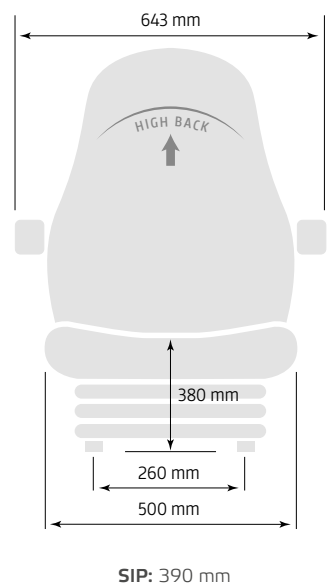

OPTIONAL FEATURES

On photo

-  **Headrest**

-  **Joystick armrests**



Seat is also available in fabric and PVC trim





HIGHLANDER PRO

STANDARD FEATURES

-  **Air suspension**
120 mm suspension travel

-  **Weight adjustment**
50 - 135 kg

-  **Height adjustment**
80 mm stepless

-  **Fore/aft isolator**

-  **Slide rail travel**
210 mm

-  **Backrest adjustment**

-  **Seat cushion depth & tilt adjustment**

-  **Adjustable damper**

-  **Headrest & armrests**

SEAT MEASUREMENTS

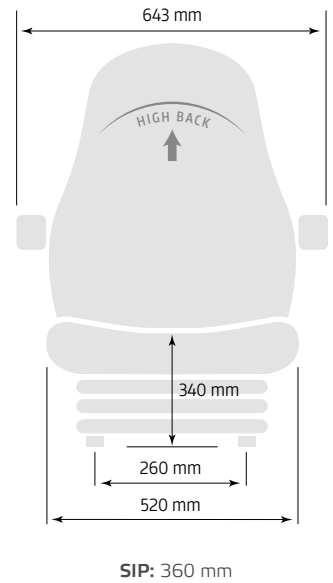

Seat is also available in PVC trim
Seat meets E5 & E11 - ISO 6683 & IWG 78/764



HIGHLANDER STD

STANDARD FEATURES

-  **Air suspension**
120 mm suspension travel

-  **Weight adjustment**
50 - 135 kg

-  **Height adjustment**
80 mm stepless

-  **Fore/aft isolator**

-  **Slide rail travel**
210 mm

-  **Backrest adjustment**

-  **Adjustable damper**

-  **Headrest & armrests**

SEAT MEASUREMENTS

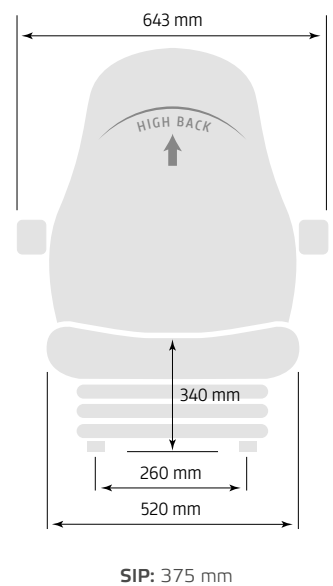

Seat is also available in PVC trim
Seat meets E5 & E11 - ISO 6683 & IWG 78/764

OPTIONAL FEATURES

On photo

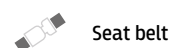

RANCHER PRO



Seat is also available in PVC trim
 Seat meets E5 & E11 - ISO 6683 & IWG 78/764

STANDARD FEATURES

-  **Air suspension**
120 mm suspension travel

-  **Weight adjustment**
50 - 135 kg

-  **Height adjustment**
80 mm stepless

-  **Fore/aft isolator**

-  **Slide rail travel**
210 mm

-  **Backrest adjustment**

-  **Seat cushion depth & tilt adjustment**

-  **Lumbar support**

-  **Headrest & armrests**

SEAT MEASUREMENTS

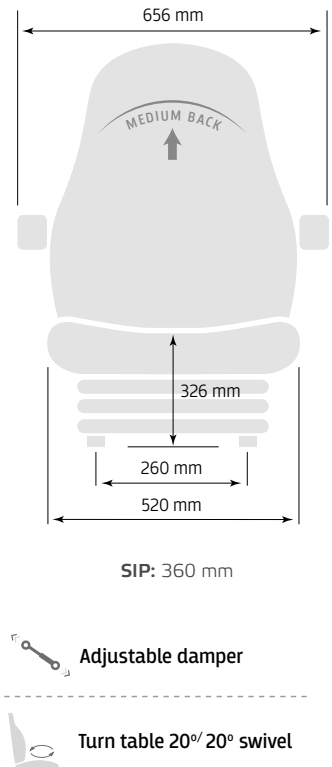



RANCHER STD





Seat is also available in PVC trim
 Seat meets E5 & E11 - ISO 6683 & IWG 78/764

STANDARD FEATURES

-  **Air suspension**
120 mm suspension travel

-  **Weight adjustment**
50 - 135 kg

-  **Height adjustment**
80 mm stepless

-  **Fore/aft isolator**

-  **Slide rail travel**
210 mm

-  **Backrest adjustment**

-  **Lumbar support**

-  **Headrest & armrests**

-  **Turn table 20°/20° swivel**

SEAT MEASUREMENTS

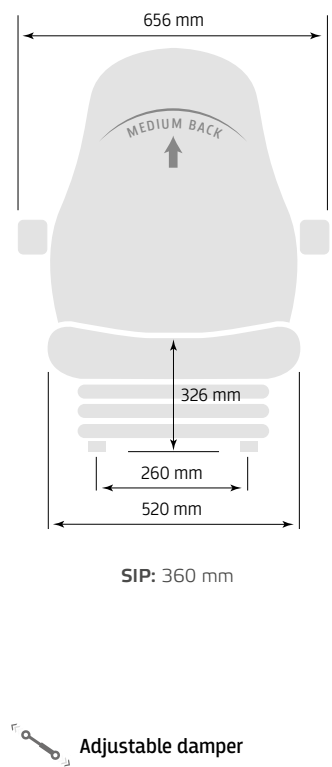



RANCHER ECO (AIR)





STANDARD FEATURES

-  **Air suspension**
120 mm suspension travel

-  **Weight adjustment**
50 - 135 kg

-  **Height adjustment**
80 mm stepless

-  **Fore/aft isolator**

-  **Slide rail travel**
210 mm

-  **Backrest adjustment**

-  **Armrests**

SEAT MEASUREMENTS

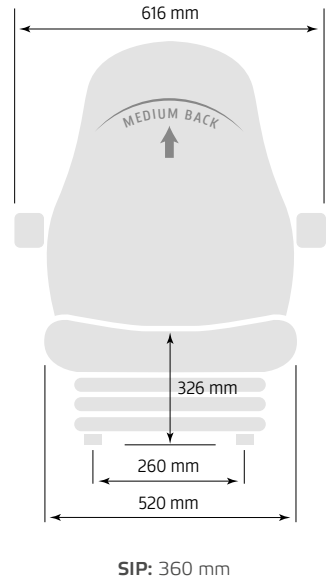



Seat is also available in PVC trim
Seat meets E5 & E11 - ISO 6683 & IWG 78/764

RANCHER ECO (MECHANICAL)





STANDARD FEATURES

-  **Mechanical suspension**
120 mm suspension travel

-  **Weight adjustment**
50 - 135 kg

-  **Slide rail travel**
210 mm

-  **Backrest adjustment**

-  **Armrests**

SEAT MEASUREMENTS

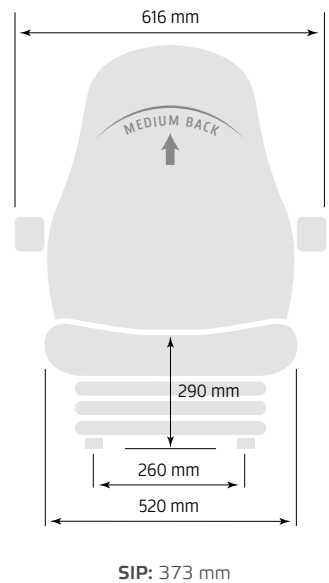



Seat is also available in PVC trim
Seat meets E5 & E11 - ISO 6683 & IWG 78/764





LGV120/C7 PRO 3P

STANDARD FEATURES

-  **Air suspension**
100 mm suspension travel

-  **Weight adjustment**
50 - 150 kg

-  **Slide rail travel**
200 mm

-  **Backrest adjustment**

-  **Seat cushion depth & tilt adjustment**

OPTIONAL FEATURES

On photo

-  **Armrests & pods**

-  **Headrest**

-  **Seat belt**

SEAT MEASUREMENTS

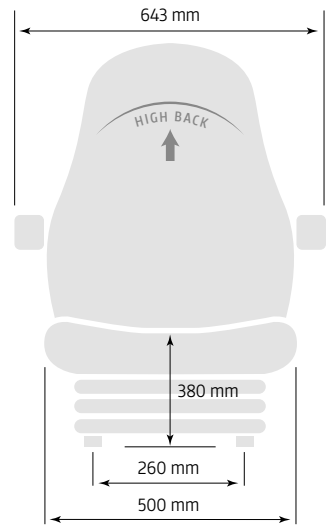

SIP: 390 mm



Seat is also available in PVC trim



LGV90/C7 PRO

STANDARD FEATURES

-  **Air suspension**
120 mm suspension travel

-  **Weight adjustment**
50 - 130 kg

-  **Height adjustment**
80 mm stepless

-  **Fore/aft isolator**

-  **Slide rail travel**
150 mm

-  **Backrest adjustment**

-  **Seat cushion depth & tilt adjustment**

OPTIONAL FEATURES

On photo

-  **Armrests**
-  **Headrest**

SEAT MEASUREMENTS

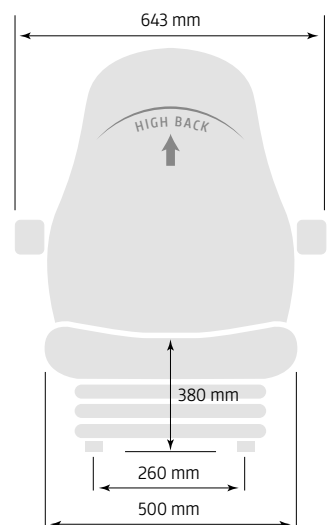

SIP: 390 mm



Seat is also available in PVC trim





Also available
in wide version



MGV55

STANDARD FEATURES

 **Mechanical suspension**
80 mm suspension travel

 **Weight adjustment**
50 - 155 kg

 **Slide rail travel**
180 mm

 **NO/NC contact switch**

 **Backrest adjustment**

 **Fold forward feature**

 **Seat belt**

SEAT MEASUREMENTS

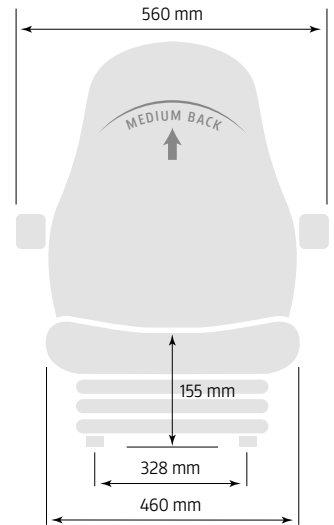

SIP: 220 mm



Meets EM1 to EM3 and EM5 to EM9

Backrest can fold fully forward

Seat is also available with seat width 490 mm

Seat is also available in fabric trim





Also available
in comfort version



MGV35

STANDARD FEATURES

 **Mechanical suspension**
80 mm suspension travel

 **Weight adjustment**
50 - 155 kg

 **Slide rail travel**
180 mm

 **NO/NC contact switch**

 **Backrest adjustment**

 **Fold forward feature**

 **Seat belt**

SEAT MEASUREMENTS

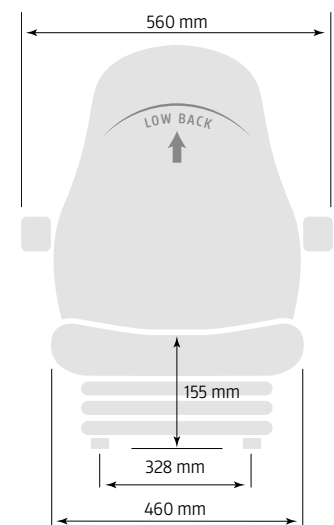

SIP: 220 mm

OEM variant - SIP: 200 mm available
upon request



Meets EM1 to EM3 and EM5 to EM9

Backrest can fold fully forward

Seat is also available in comfort version with seat width 490 mm

Seat is also available in fabric trim

LGV90/C2 PRO





STANDARD FEATURES

-  **Air suspension**
120 mm suspension travel

-  **Weight adjustment**
50 - 130 kg

-  **Height adjustment**
80 mm stepless

-  **Fore/aft isolator**

-  **Slide rail travel**
200 mm

-  **Backrest adjustment**

-  **Seat cushion depth & tilt adjustment**

SEAT MEASUREMENTS

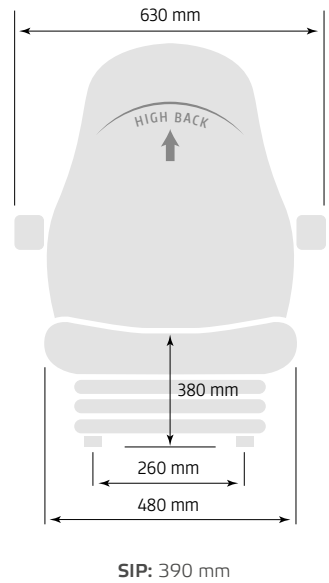

OPTIONAL FEATURES

On photo

-  **Armrests**
-  **Headrest**



Seat is also available in PVC trim

CS85/C7 PRO



STANDARD FEATURES

-  **Mechanical suspension**
90 mm suspension travel

-  **Weight adjustment**
50 - 125 kg

-  **Height adjustment**
60 mm in 3 stages

-  **Slide rail travel**
200 mm

-  **Backrest adjustment**

-  **Seat cushion depth & tilt adjustment**

SEAT MEASUREMENTS

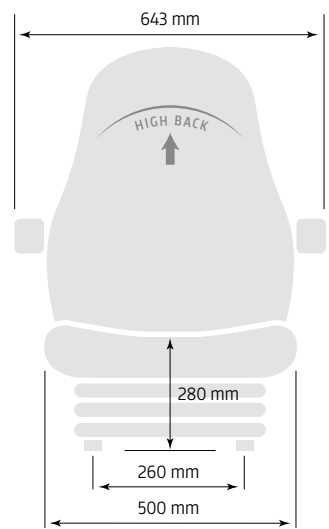

OPTIONAL FEATURES

On photo

-  **Armrests**

-  **Headrest**



Seat is also available in PVC trim



CS85/C1

STANDARD FEATURES

-  **Mechanical suspension**
90 mm suspension travel
-  **Weight adjustment**
50 - 125 kg
-  **Height adjustment**
60 mm in 3 stages
-  **Slide rail travel**
150 mm
-  **Backrest adjustment**
-  **Lumbar support**

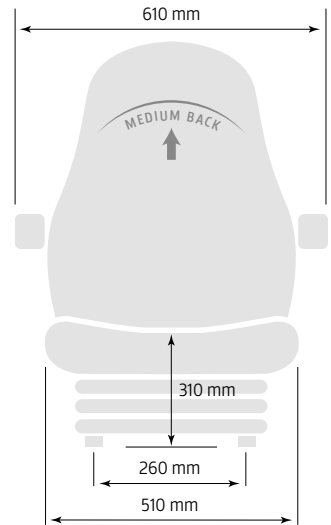

SEAT MEASUREMENTS



SIP: 324 mm

OPTIONAL FEATURES

On photo

-  **Armrests**
-  **Headrest**
-  **Seat belt**





Seat is also available in PVC trim



MGV25/C5

STANDARD FEATURES

-  **Mechanical suspension**
45 mm suspension travel
-  **Weight adjustment**
50 - 130 kg
-  **Slide rail travel**
150 mm
-  **Backrest adjustment**

SEAT MEASUREMENTS

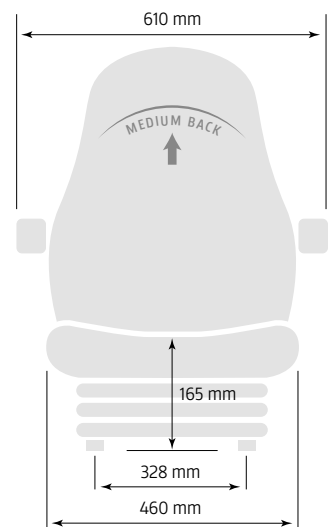

SIP: 245 mm

OPTIONAL FEATURES

On photo

-  **Armrests**
-  **Headrest**





Seat is also available in PVC trim

MGV25





STANDARD FEATURES

 **Mechanical suspension**
50 mm suspension travel

 **Weight adjustment**
50 - 125 kg

 **Slide rail travel**
150 mm

 **Operator presence switch**

 **Backrest adjustment**

 **Fold forward feature**

OPTIONAL FEATURES

On photo

 **Seat belt**

SEAT MEASUREMENTS

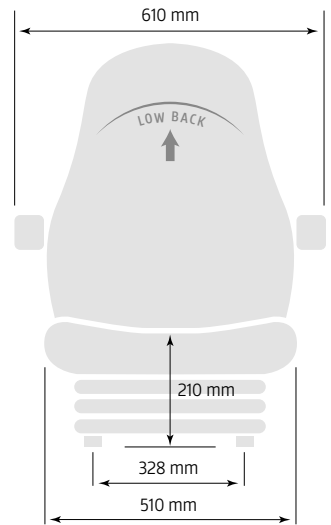

SIP: 225 mm





Seat is in heavy duty PVC. Also available in fabric trim

US20





STANDARD FEATURES

 **Mechanical suspension**
40 mm suspension travel

 **Weight adjustment**
60 - 120 kg

 **Slide rail travel**
150 mm

 **Slide rail adjustment**
150-328 mm in width

 **Operator presence switch**

 **Backrest adjustment**

SEAT MEASUREMENTS

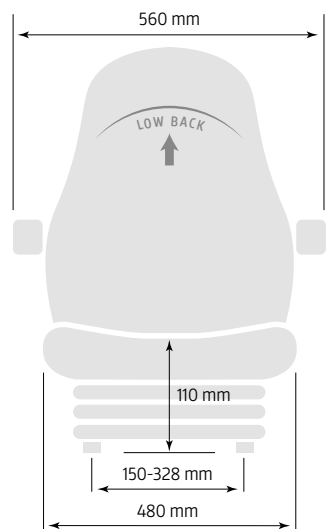

SIP: 160 mm



Seat is in heavy duty PVC. Also available in fabric trim

Mi900

STANDARD FEATURES

Water- and weather proof

High backrest

Plastic shell

Multi hole mounting pattern

Black PVC

OPTIONAL FEATURES

Contact switch

Seat belt

Slide rails

Suspension

SEAT MEASUREMENTS

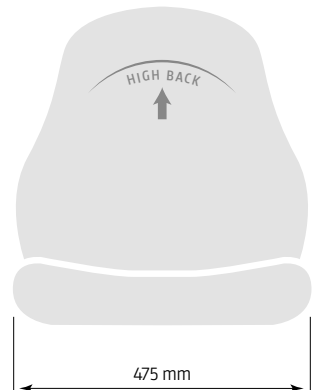

Plastic pan seat fits a variety of small/compact construction machines

Mi600

STANDARD FEATURES

Heavy duty PVC

Water- and weather proof

Plastic shell

Multi hole mounting pattern

Black PVC

OPTIONAL FEATURES

Contact switch

Seat belt

Slide rails

Suspension

Yellow PVC

Grey PVC

SEAT MEASUREMENTS

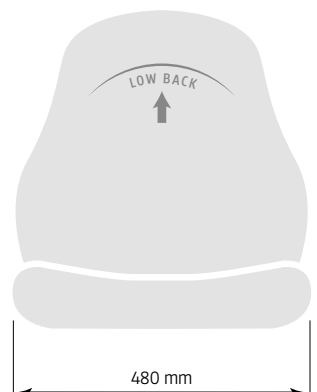

Plastic pan seat fits a variety of small/compact construction machines

SEAT OPTIONS

Different types of armrests



Multi adjustable armrests



Air & mechanical suspensions



Slide rails



Various seat belts



Turntables



SEAT OPTIONS

Contact switch

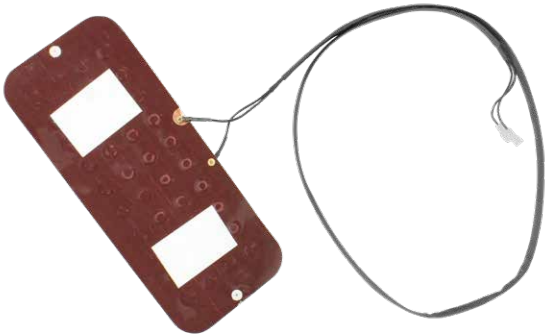

Delta switch NO/NC



Fore/aft isolator



Heating



Joystick console



Headrests and custom logo



SPECIALTY PRODUCTS & BUILDS

Various builds and options for seats.
Further options available upon request.



LGV90/C7 Pro with pods



MGV35 with joystick armrest



C5 upper with logo

SEAT & BACK CUSHIONS

Fabric and PVC replacement cushions.
Further options available upon request.



SPECIALTY PRODUCTS & BUILDS

Custom build 2, 3 & 4-point seat belt.
Further options available upon request.



2-point Hi-Viz seat belt



3-point Hi-Viz seat belt



4-point red belt harness

2-, 3- AND 4-POINT SEAT BELTS

ALR/ELR type available.
Further options available upon request.

ON.151107



ON.151109



ON.150757S



ON.151108



ON.150756S



ON.150855





OFF ROAD **SEATING** MANUFACTURER

Custom **made in** Holland



At UnitedSeats we are dedicated to providing a quality service from the initial quotation to final product delivery. Our commitment to service, knowledge and product availability has made us the preferred source for your seating needs.

WWW.UNITEDSEATS.COM

